

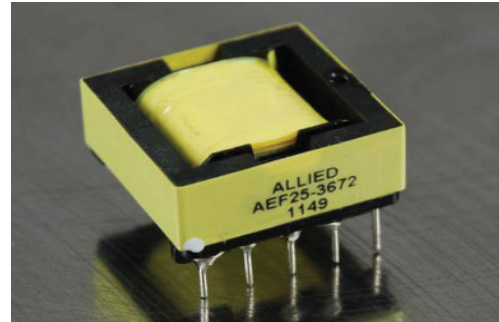

EFD25 Transformer

AEF25-3672



DIMENSION: (UNIT: mm)

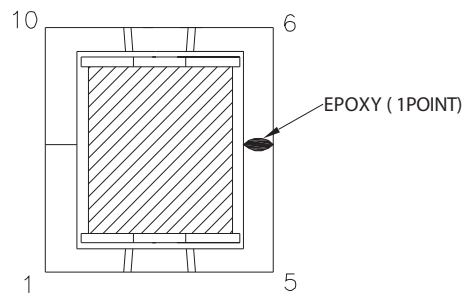

TOP VIEW

MARKING:

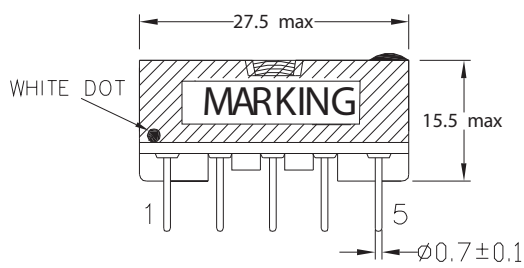
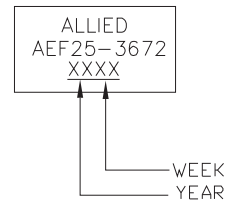

FRONT VIEW

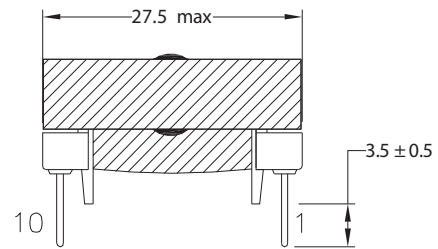

SIDE VIEW

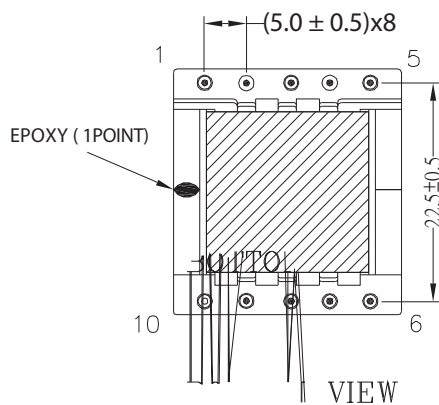

VIEW

NOTE: PIN10 NO.



SCHEMATIC

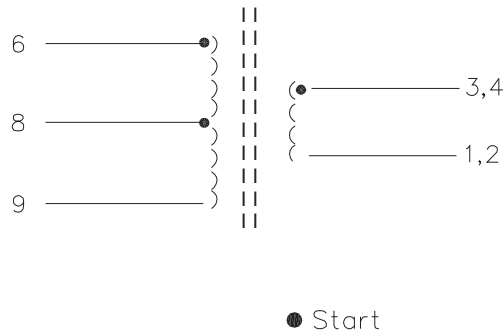

WINDNG SUMMARY:

WINDING ORDER	TERMINAL (S - F)	WIRE SIZE	TURN	MARGIN TAPE	INSULATION TAPE	REMARK
#1	N1	6-8	14Ts	2.0mm/2.0mm	3 LAYERS	2 Wires
#2	N2	3,4-1,2	7Ts	2.0mm/2.0mm	3 LAYERS	2 Wires
#3	N3	8-9	14Ts	2.0mm/2.0mm	2 LAYERS	2 Wires

CONSTRUCTION

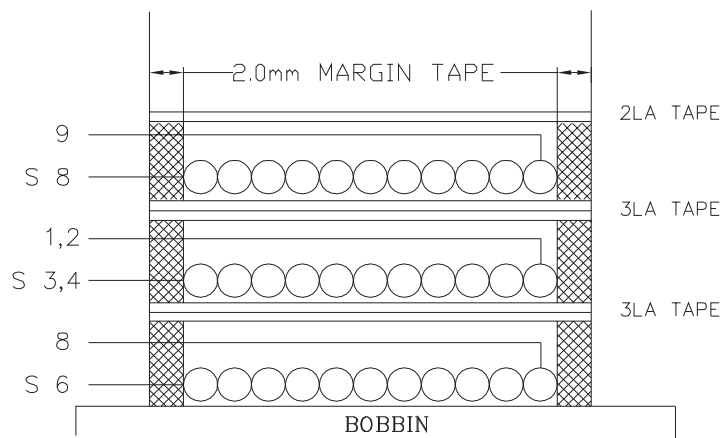



SPECIFICATION

1.PRIMARY ELECTRONIC SPEC:

S - F	INDUCTANCE F=1 KHZ, 1.0VRMS, 25°C	LEAKAGE INDUCTANCE F=1 KHZ, 1VRMS,25°C (SHORT OTHER PINS)	DCR 25°C (MAX)	TURN RATIO
6 - 9	64uH±10%	20uH max	180 mOhm	28 Ts
-	-	-	-	-

2.SECONDARY ELECTRONIC SPEC:

S - F	INDUCTANCE F=1KHZ,1.0VRMS 25°C	LEAKAGE INDUCTANCE F=1KHZ,1.0VRMS (SHORT PIN)	DCR 25°C (MAX)	TURN RATIO
3,4 - 1,2	-	-	16 mOhm	7Ts

3.HI-POT/INSULATION RESISTANCE:

LOCAT. \ DESC.	PRI-PRI	PRI-SEC	SEC-SEC	PRI-CORE	SEC-CORE
HI-POT (50Hz/60Hz)	-	1000V _{ac} 5mA, 2SEC	-	500V _{ac} 5mA, 2SEC	500V _{ac} 5mA, 2SEC
INSULATION RESISTANCE	-	500V _{dc} 100 MOhm min	-	500V _{dc} 100 MOhm min	500V _{dc} 100 MOhm min



MATERIAL LIST

ITEM	NAME	DESCRIPTION	UL NO.	VENDOR
1.	CORE	FERRITE CORE: EFD25 3C95,P47,DMR95,TPW33	—	FERROXCUBE,ACME,DMEGC,TDG.
2.	BOBBIN	PHENOLIC 94V-0 PM-9820/PM-9630	E41429	Sumitomo Bakelite co.,Ltd.
3.	WIRE	TYPU-130(UEW-B) TYTUN-B130(UEWNY-B) UEW-4#/UEY-2#	E197768 E174837	Heng ya electric(dongguan) Ltd. Jung shing wire co., Ltd.
4.	MYLAR TAPE (YELLOW)	CT(c) NO.35660Y*(%)	E165111 E50292	Jingjiang yahua pressure sensitive glue co., Ltd. Symbio inc.
5.	MARGIN TAPE	WF(c) 35661\$	E165111 E50292	Jingjiang yahua pressure sensitive glue co., Ltd. Symbio inc.
6.	VARNISH	WP-2952F-2G ES925-43D# DVB-2085(*)	E72979 E258329 E93947	Hitachi chemica co ltd. Chemtech Co.,Ltd. Noroo paint & coatings co.,Ltd.
7.	EPOXY	H907 K1408 K2408	E304477 E101381 —	Dong Guan shi pai hua chuang material fty. Flying Dragons Material industrial co.,ltd Flying Dragons Material industrial co.,ltd
8.	TERMINALS	Tin plated- copper wire	—	Well Fore Special wire corp.
9.	SOLDER	Pb<1000ppm	—	—